

## Panduct® PanelMax™ Corner Wiring Duct – Space Saving One-Piece Construction

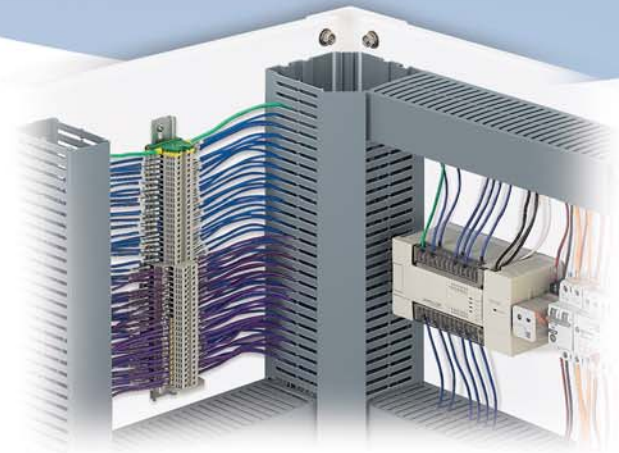

Panduct® PanelMax™ Corner Wiring Duct is an innovative one-piece wire management product which makes more efficient use of space inside enclosures, speeds installation, and reduces control panel assembly costs. PanelMax™ Corner Wiring Duct is used in the vertical corners of compact to large electrical control panels (with both side and back panels) to route, conceal, and protect electrical wiring. PanelMax™ Corner Wiring Duct is part of a complete line of Panduit wire management solutions for control panels.



### Key Features

### Benefits

<b>Angled four-sided channel design</b>	Fits in the unused space in the vertical corner of enclosures and provides up to five square feet of additional sub-panel space for mounting control components or up to 20% savings in enclosure footprint area*
<b>One-piece channel with co-extruded flexible hinges</b>	Requires no assembly; easily locates and conforms to the corner of the enclosure for faster installation than conventional multi-piece solutions
<b>Quick mount clips</b>	Require minimal hardware for reduced installation time; once installed, the base is easily snapped into place on the clips
<b>Integrated mounting feature for divider wall</b>	For applications requiring wire separation, the standard Panduit 4" divider wall simply snaps onto the base to create two channels
<b>Compatible with standard wiring duct and cover</b>	Provides a consistent, neat panel appearance when used with Panduit 2", 3", and 4" height wiring ducts; PanelMax™ Corner Wiring Duct uses standard Panduit 2" wiring duct cover for simplicity in ordering
<b>Lead-free, UL compliant PVC material</b>	Meets European Directive 2002/95/EC on the Restriction of Hazardous Substances (RoHS); maintains UL94 flammability rating of V-0 and UL recognized continuous-use temperature to 50°C (122°F)
<b>Extended cover neck</b>	Eases cover installation and removal; at intersections, standard Panduit wiring duct fits flush against the PanelMax™ Corner Wiring Duct without exposed seams for an aesthetic appearance
<b>Double scorelines</b>	Upper score line allows duct finger removal without tools for quick modifications during wire installation; lower score line eases sidewall section removal at tee intersections ensuring full wire carrying capacity

\*Actual sub-panel space savings will vary depending on wiring duct size, component layout, and enclosure size and type. Footprint savings is based on commercially available enclosures and may not be achievable in some applications.

# Panduct® PanelMax™ Corner Wiring Duct



## Utilize Unused Space

PanelMax™ Corner Wiring Duct utilizes the unused space in enclosures with both back and side panels

### Conventional Layout for Control Enclosure with Side Panels

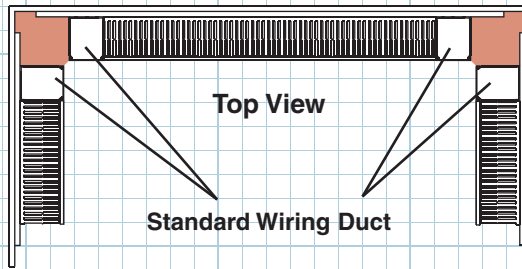

Unused Corner Space

### PanelMax™ Corner Wiring Duct Increases Usable Sub-Panel Area within the Same Size Panel

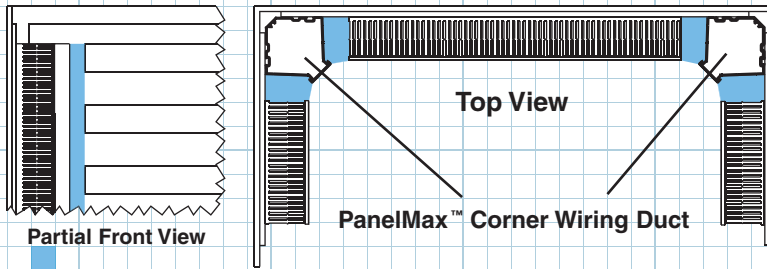

Sub-Panel Space Savings

### PanelMax™ Corner Wiring Duct Reduces Required Enclosure Size and Floor Space

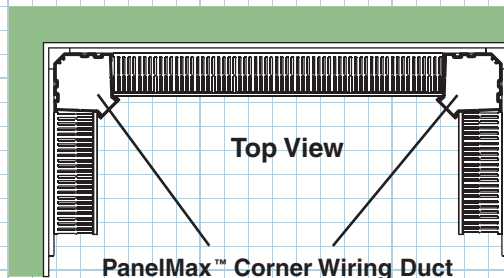

Footprint Space Savings

## Add More Components

Free up as much as five square feet of sub-panel space for more component room

- OR -

## Reduce Your Enclosure Size

Decrease enclosure footprint area up to 20%

## Example of Space Savings Using 48"W x 24"D x 60"H Enclosure

Description	Conventional	With PanelMax™ Corner Wiring Duct	Benefits
<b>Sub-Panel Space Savings</b>			
Usable sub-panel mounting area (assumes 60"H enclosure)	28.7 ft. <sup>2</sup>	32.2 ft. <sup>2</sup>	Provides 12% more space, maximizing space utilization for more panel components and greater flexibility in panel layout design
<b>Footprint Space Savings</b>			
Footprint width x depth (square footage)	48" x 24" (8 ft. <sup>2</sup> )	43.5" x 21.7" (6.6 ft. <sup>2</sup> )	18% reduction in enclosure size; ideal for space constrained environments
Floor space cost**	\$560	\$462***	18% floor space savings to the end user
Enclosure and sub-panel costs	\$3,700	\$3,050***	\$650 in enclosure savings

\*\*Based on \$70/square foot industrial facility construction cost.

\*\*\*This is a representative application. Actual savings dependent on wiring duct size, component layout and enclosure size and type. Footprint savings is based on commercially available enclosures and may not be achievable in some applications.

# Panduct® PanelMax™ Corner Wiring Duct

## Ordering Information

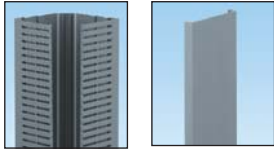

CWD2LG6  
CWD3LG6  
CWD4LG6

C2LG6

Part Number	Part Description	Duct Size W x H (in)	Duct Size W x H (mm)	Cover Part Number	Std. Pkg. Qty.	Std. Ctn. Qty.
CWD2LG6	One-piece corner wiring duct base for use with 2" height wiring duct. Base and covers sold separately.	3.35 x 2.57	85.0 x 65.3	C2LG6	6	24
CWD3LG6	One-piece corner wiring duct base for use with 3" height wiring duct. Base and covers sold separately.	4.40 x 3.57	111.8 x 90.7	C2LG6	6	24
CWD4LG6	One-piece corner wiring duct base for use with 4" height wiring duct. Base and covers sold separately.	5.33 x 4.58	135.3 x 115.7	C2LG6	6	24

Part numbers shown in LG (Light Gray); also available in WH (White).  
Standard Package Quantity and Standard Carton Quantity in feet.

## Accessories

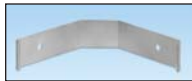

CDCLP



CDLB

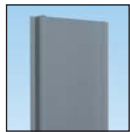

D4H6



SD4H6

Part Number	Part Description	Fastener Size	Std. Pkg. Qty.	Std. Ctn. Qty.
CDCLP3	Quick mounting clip for installing CWD3 corner wiring duct.	#10-32 x 1/2" (user supplied)	16	80
CDCLP4	Quick mounting clip for installing CWD4 corner wiring duct.	#10-32 x 1/2" (user supplied)	16	80
CDLB3	L-bracket with quick mount clip for installing CWD3 corner wiring duct to back panel only.	#10-32 x 1/2" (user supplied)	16	0
CDLB4	L-bracket with quick mount clip for installing CWD4 corner wiring duct to back panel only.	#10-32 x 1/2" (user supplied)	16	0
D4H6	4" height solid divider wall for use with CWD2, CWD3, or CWD4 corner wiring duct.	No fastener required	6	120
SD4H6	4" height slotted divider wall for use with CWD2, CWD3, or CWD4 corner wiring duct.	No fastener required	6	120

Order number of pieces required, in multiples of Standard Package Quantity.  
D4H6 and SD4H6 can be used with CWD2, CWD3, or CWD4 corner wiring duct.  
Standard Package Quantity and Standard Carton Quantity in feet.

## Mounting Options \*

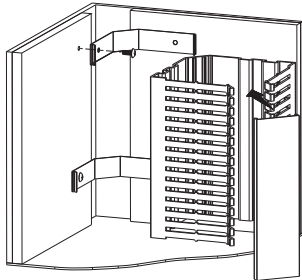

Quick mount clip style installation of PanelMax™ Corner Wiring Duct

- OR -

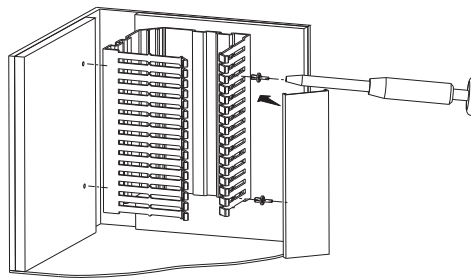

Direct mount style installation of PanelMax™ Corner Wiring Duct using TNR tool and NR1 rivets (shown) or screws

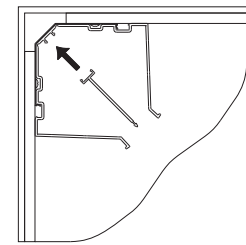

PanelMax™ Corner Wiring Duct with divider wall

\*For use with side and back panels

Note: For best results, Panduit recommends the use of a band saw or radial arm saw with plastic cutting blade to cut PanelMax™ Corner Wiring Duct.

## Panduct® PanelMax™ Corner Wiring Duct – Wirefill Capacity

NOMINAL DUCT SIZE (W x H) inches	AREA in <sup>2</sup>	ELECTRICAL														COMMUNICATION					
		8 AWG		10 AWG		12 AWG		14 AWG		16 AWG		18 AWG		22 AWG	23 AWG	23/24 AWG	24 AWG	Fiber Cable			
		THHN	THHN	THHN	MTW	MTW	THHN	MTW	MTW	TFFN	MTW	MTW	TFFN	MTW	MTW	Cat. 6A	Cat. 6 or 6A (SD)	Cat. 5e	3.0 mm		
		0.216	0.164	0.13	0.141	0.152	0.111	0.124	0.133	0.096	0.111	0.118	0.084	0.1	0.106	0.085	0.3	0.24	0.225	0.118	
CWD2	3.40 x 2.60	9.752	104	181	288	245	211	395	317	275	529	395	350	691	487	433	674	54	84	96	349
CWD3	4.40 x 3.60	17.58	188	326	520	442	380	713	571	496	953	713	631	1245	879	782	1216	97	152	173	630
CWD4	5.40 x 4.60	26.92	288	500	796	677	582	1092	875	760	1460	1092	966	1907	1346	1197	1862	149	233	265	964

Table shows maximum wire fill based on 50% of duct internal cross sectional area. Formula = Area/2.00 x D<sup>2</sup>.  
The above communication cable diameters represent the nominal Panduit cable diameter per performance level.

# Panduct® PanelMax™ Corner Wiring Duct

## Material Specifications

Properties	Lead-free PVC Material	Test Method
<b>General</b>		
Specific Gravity	1.46 g/cc	ASTM D 792
<b>Mechanical</b>		
Tensile Strength at Yield	5,600 psi	ASTM D 638
Flexural Strength	9,100 psi	ASTM D 790
Flexural Modulus	412,000 psi	ASTM D 790
Notched Izod Impact at 23°C (73°F)	4.0 ft.-lbs./in.	ASTM D 256
Heat Deflection Temperature at 264 psi	156°F	ASTM D 648
<b>Flammability</b>		
Limited Oxygen Index (LOI)	35	ASTM D 2863
Smoke Density (Flaming) at 4 minutes	538	ASTM E 662
Flammability Class	V-0	UL94
<b>Agency Approvals</b>		
UL Recognized file E147128, CSA Certified file 016446-0-00		
CE Information	<ul style="list-style-type: none"> <li>• CDS for impact to 2J</li> <li>• Non-flame propagating</li> <li>• Temperature range: -25°C to 60°C</li> </ul>	

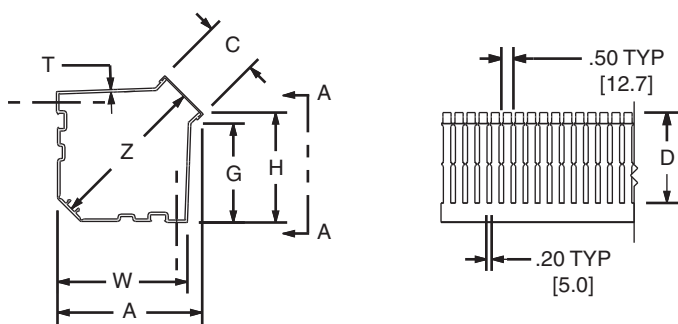

View A - A

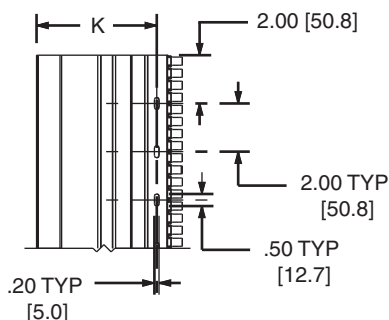

### Duct Dimensions

For Corner Wiring Duct Installation Instructions (RW207), go to [panduit.com](http://panduit.com)

Part Number	A	C	D	G	H	K	T	W	Z
<b>CWD2**6</b>	3.91" (99.3 mm)	2.25" (57.2 mm)	1.81" (45.9 mm)	2.10" (53.4 mm)	2.57" (65.3 mm)	2.93" (74.3 mm)	0.08" (2.0 mm)	3.35" (85.0 mm)	3.72" (94.6 mm)
<b>CWD3**6</b>	4.98" (126.6 mm)	2.25" (57.2 mm)	2.83" (71.8 mm)	3.10" (79.1 mm)	3.57" (90.7 mm)	3.95" (100.4 mm)	0.10" (2.4 mm)	4.40" (111.8 mm)	5.16" (131.0 mm)
<b>CWD4**6</b>	5.94" (150.9 mm)	2.25" (57.2 mm)	3.84" (97.5 mm)	4.10" (104.1 mm)	4.58" (115.7 mm)	4.89" (124.3 mm)	0.11" (2.7 mm)	5.33" (135.3 mm)	6.54" (166.0 mm)



**DFCT - Duct Finger Cutting Tool**  
Easily removes duct fingers in tight places



**NR1 - Nylon Rivet**  
For use with TNR tool



**TNR - Nylon Rivet Installation Tool**  
Hand-held tool for easy rivet installation



**DNT-100 - Notching Tool**  
Notches duct sidewalls to bottom scoreline for tees and corners

### WORLDWIDE SUBSIDIARIES AND SALES OFFICES

PANDUIT CANADA  
Markham, Ontario  
cs-cdn@panduit.com  
Phone: 800.777.3300

PANDUIT EUROPE LTD.  
London, UK  
cs-emea@panduit.com  
Phone: 44.20.8601.7200

PANDUIT SINGAPORE PTE. LTD.  
Republic of Singapore  
cs-ap@panduit.com  
Phone: 65.6305.7575

PANDUIT JAPAN  
Tokyo, Japan  
cs-japan@panduit.com  
Phone: 81.3.6863.6000

PANDUIT LATIN AMERICA  
Guadalajara, Mexico  
cs-la@panduit.com  
Phone: 52.33.3777.6000

PANDUIT AUSTRALIA PTY. LTD.  
Victoria, Australia  
cs-aus@panduit.com  
Phone: 61.3.9794.9020

For a copy of Panduit product warranties, log on to [www.panduit.com/warranty](http://www.panduit.com/warranty)

**PANDUIT®**

For more information  
Visit us at [www.panduit.com](http://www.panduit.com)  
Contact Customer Service by email: [cs@panduit.com](mailto:cs@panduit.com)  
or by phone: 800.777.3300

©2013 Panduit Corp.  
ALL RIGHTS RESERVED.  
Product Bulletin Number **WDCB30--WW-ENG**  
Replaces SA-WDCB15  
1/2013